

**PRELIMINARY**  
 Notice: This is not a final specification.  
 Some parametric limits are subject to change.

MITSUBISHI Nch POWER MOSFET

# FL10KM-12A

HIGH-SPEED SWITCHING USE

## FL10KM-12A

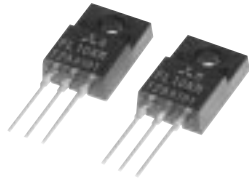

- 10V DRIVE
- V<sub>DSS</sub> ..... 600V
- r<sub>DS</sub> (ON) (MAX) ..... 1.1Ω
- I<sub>D</sub> ..... 10A

## OUTLINE DRAWING

Dimensions in mm

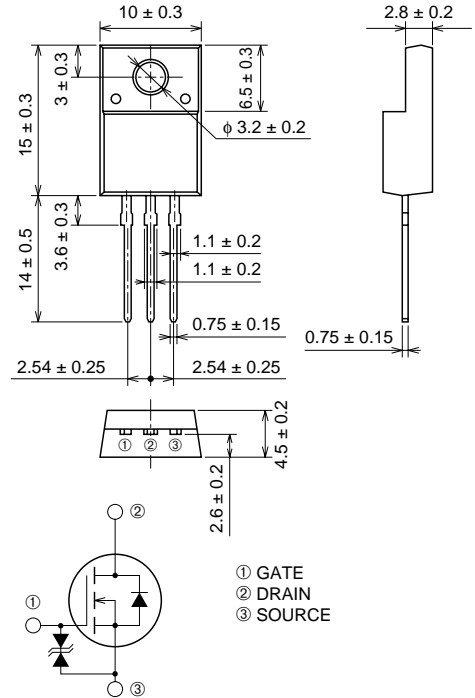

TO-220FN

## APPLICATION

Switch mode power supply, Inverter fluorescent lamp, etc.

## MAXIMUM RATINGS (T<sub>c</sub> = 25°C)

Symbol	Parameter	Conditions	Ratings	Unit
V <sub>DSS</sub>	Drain-source voltage	V <sub>GS</sub> = 0V	600	V
V <sub>GSS</sub>	Gate-source voltage	V <sub>DS</sub> = 0V	±30	V
I <sub>D</sub>	Drain current		10	A
I <sub>DM</sub>	Drain current (Pulsed)		30	A
I <sub>DA</sub>	Avalanche drain current (Pulsed)	L = 200μH	10	A
P <sub>D</sub>	Maximum power dissipation		40	W
T <sub>ch</sub>	Channel temperature		-55 ~ +150	°C
T <sub>stg</sub>	Storage temperature		-55 ~ +150	°C
V <sub>iso</sub>	Isolation voltage	AC for 1minute, Terminal to case	2000	V
—	Weight	Typical value	2.0	g

Sep.1998

**PRELIMINARY**  
 Notice: This is not a final specification.  
 Some parametric limits are subject to change.

**ELECTRICAL CHARACTERISTICS** (Tch = 25°C)

Symbol	Parameter	Test conditions	Limits			Unit
			Min.	Typ.	Max.	
V (BR) DSS	Drain-source breakdown voltage	Id = 1mA, VGS = 0V	600	—	—	V
V (BR) GSS	Gate-source breakdown voltage	IGS = ±100µA, VDS = 0V	±30	—	—	V
IGSS	Gate-source leakage current	VGS = ±25V, VDS = 0V	—	—	±10	µA
IdSS	Drain-source leakage current	VDS = 600V, VGS = 0V	—	—	1	mA
VGS (th)	Gate-source threshold voltage	Id = 1mA, VDS = 10V	2.0	3.0	4.0	V
rDS (ON)	Drain-source on-state resistance	Id = 5A, VGS = 10V	—	0.92	1.10	Ω
VDS (ON)	Drain-source on-state voltage	Id = 5A, VGS = 10V	—	4.60	5.50	V
yfs	Forward transfer admittance	Id = 5A, VDS = 10V	—	7.0	—	S
Ciss	Input capacitance	VDS = 25V, VGS = 0V, f = 1MHz	—	1150	—	pF
Coss	Output capacitance		—	135	—	pF
Crss	Reverse transfer capacitance		—	45	—	pF
td (on)	Turn-on delay time	VDD = 200V, Id = 5A, VGS = 10V, RGEN = RGS = 50Ω	—	24	—	ns
tr	Rise time		—	40	—	ns
td (off)	Turn-off delay time		—	220	—	ns
tf	Fall time		—	85	—	ns
VSD	Source-drain voltage	IS = 5A, VGS = 0V	—	1.5	2.0	V
Rth (ch-c)	Thermal resistance	Channel to case	—	—	3.13	°C/W

**PERFORMANCE CURVES**

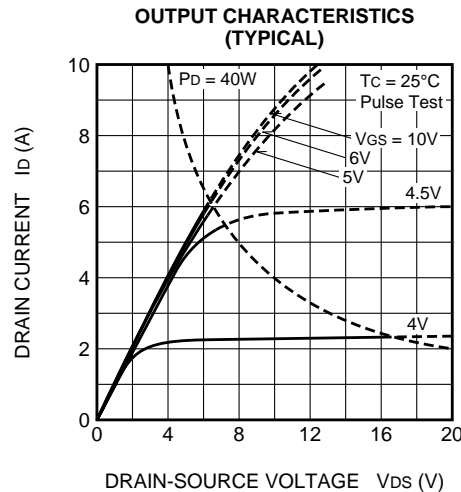
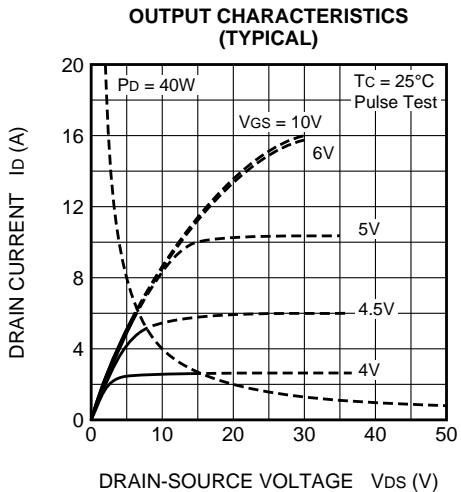
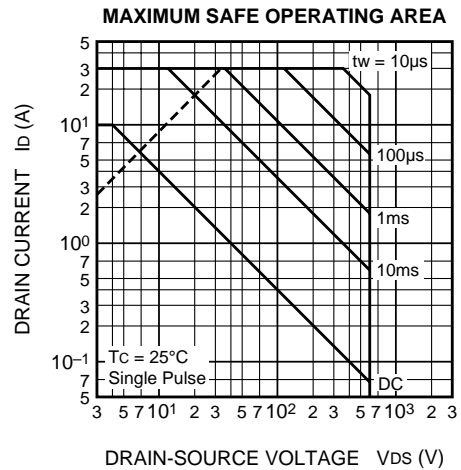
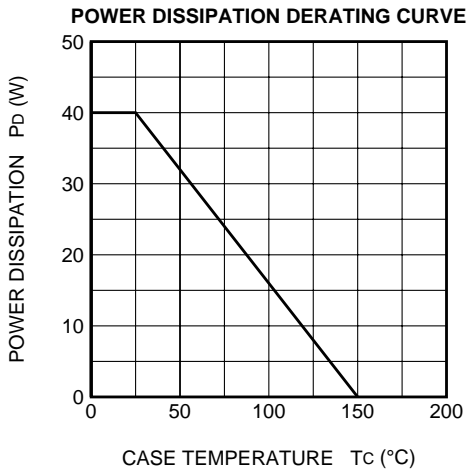

**PRELIMINARY**  
 Notice: This is not a final specification.  
 Some parametric limits are subject to change.

**ON-STATE VOLTAGE VS. GATE-SOURCE VOLTAGE (TYPICAL)**

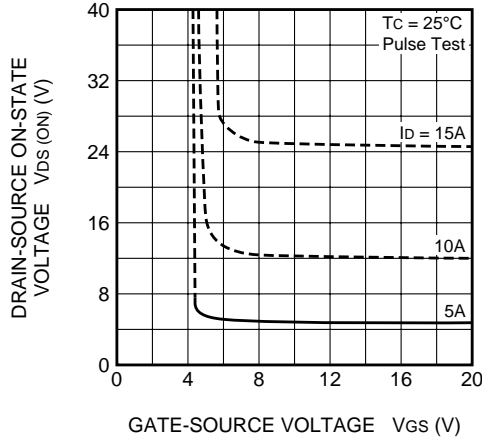

**ON-STATE RESISTANCE VS. DRAIN CURRENT (TYPICAL)**

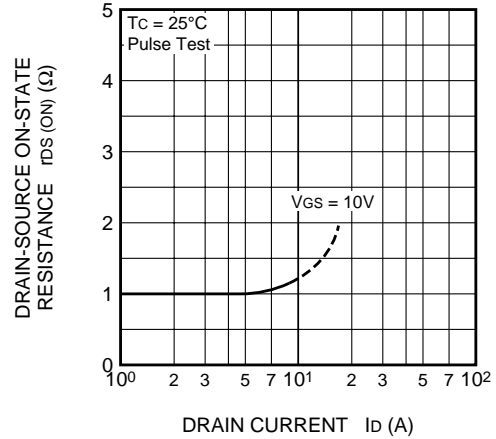

**TRANSFER CHARACTERISTICS (TYPICAL)**

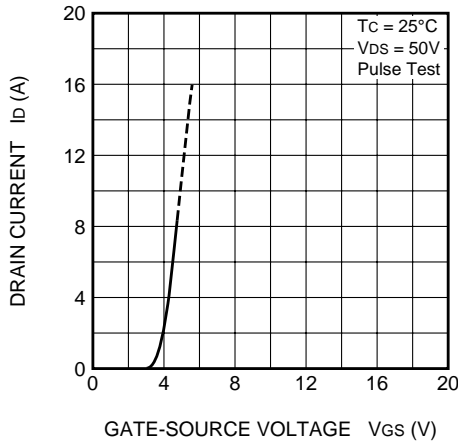

**FORWARD TRANSFER ADMITTANCE VS. DRAIN CURRENT (TYPICAL)**

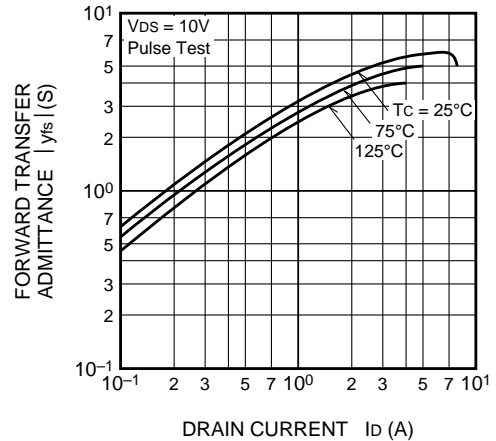

**CAPACITANCE VS. DRAIN-SOURCE VOLTAGE (TYPICAL)**

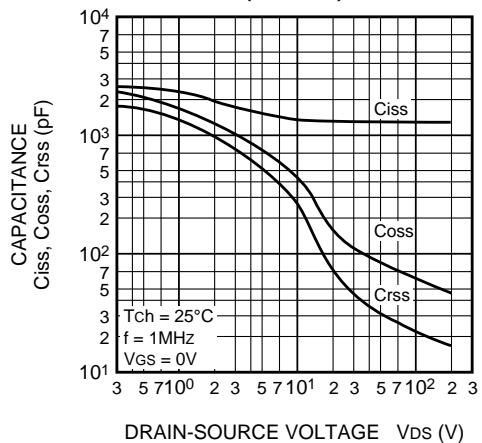

**SWITCHING CHARACTERISTICS (TYPICAL)**

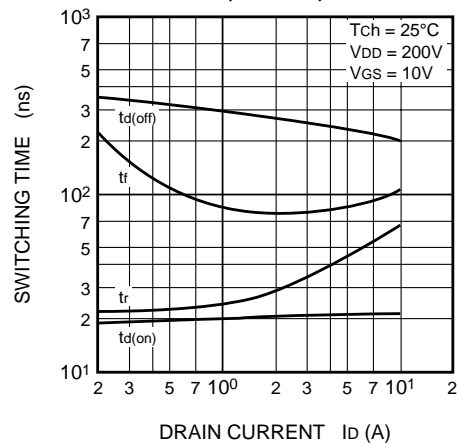

**PRELIMINARY**  
 Notice: This is not a final specification.  
 Some parametric limits are subject to change.

**GATE-SOURCE VOLTAGE VS. GATE CHARGE (TYPICAL)**

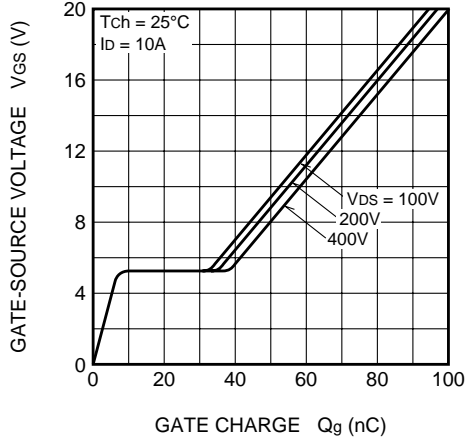

**SOURCE-DRAIN DIODE FORWARD CHARACTERISTICS (TYPICAL)**

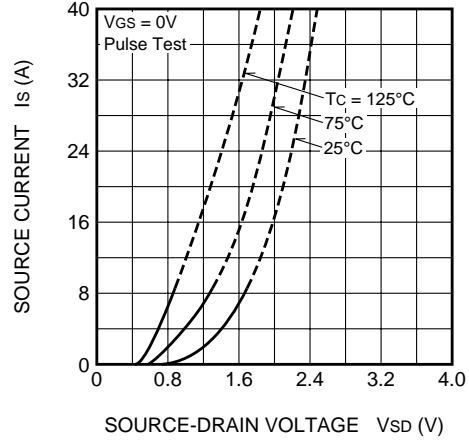

**ON-STATE RESISTANCE VS. CHANNEL TEMPERATURE (TYPICAL)**

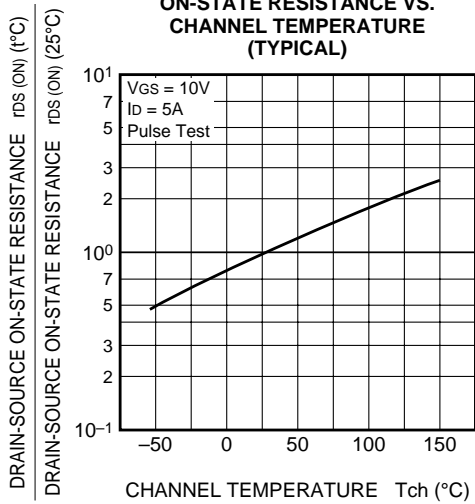

**THRESHOLD VOLTAGE VS. CHANNEL TEMPERATURE (TYPICAL)**

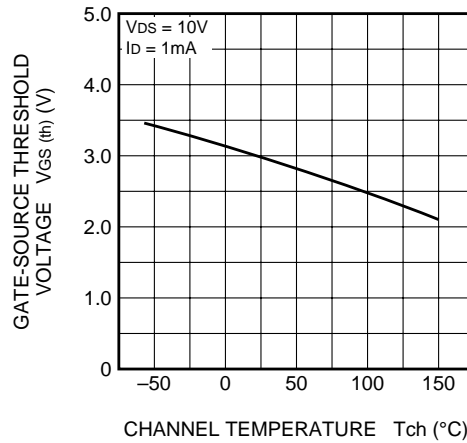

**BREAKDOWN VOLTAGE VS. CHANNEL TEMPERATURE (TYPICAL)**

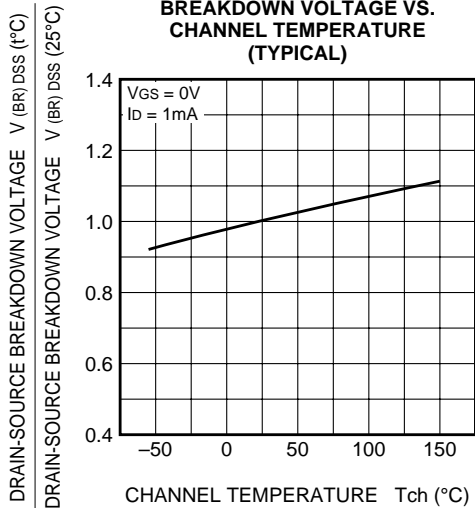

**TRANSIENT THERMAL IMPEDANCE CHARACTERISTICS**

